



---

REVISION HISTORY

DEVICE ORDER INFORMATION

ABSOLUTE MAXIMUM RATINGS

Over operating free-air temperature unless otherwise

---

### RECOMMENDED OPERATING CONDITIONS

### ESD RATINGS

(1)  
(2)

### THERMAL INFORMATION

---

## ELECTRICAL CHARACTERISTICS

---

---

FUNCTIONAL BLOCK DIAGRAM

EN

FB

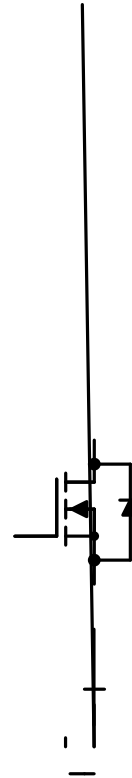
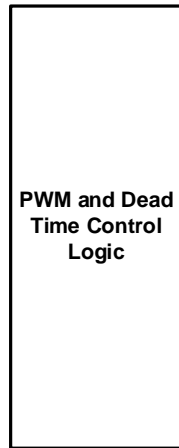
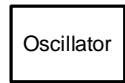

---

---

---

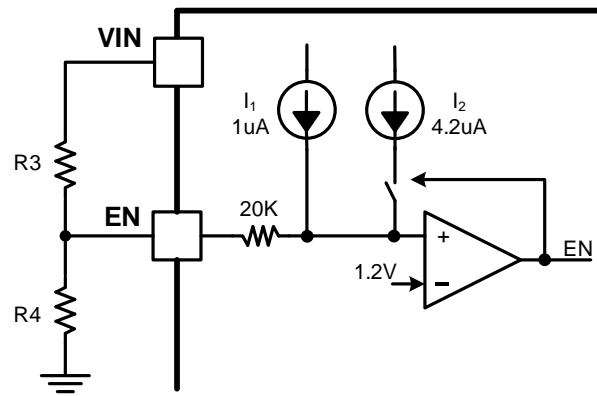



---

---

---

---

---

---



---

(6)

(7)

(8)

(9)

---

\_\_\_\_\_ (10)

\_\_\_\_\_ \_\_\_\_\_

\_\_\_\_\_ (12)



---

Figure 12. Power Up, IOU=3A

Figure 13. Power Down, IOU=3A

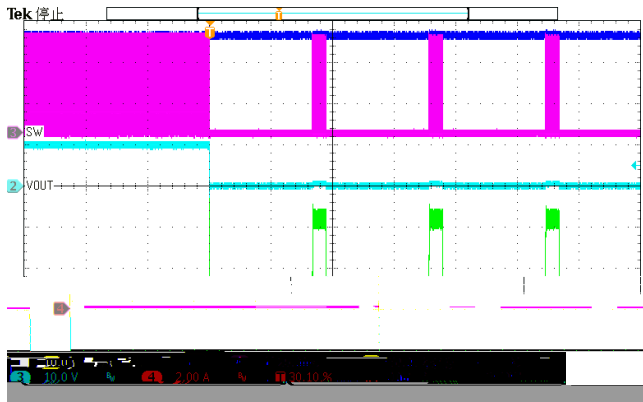

Figure 18. Over Current Protection(0A to hard short)

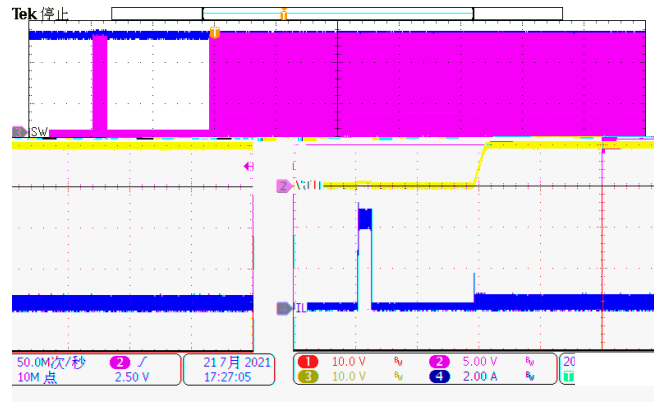

Figure 19. Over Current Release (hard short to 0A)

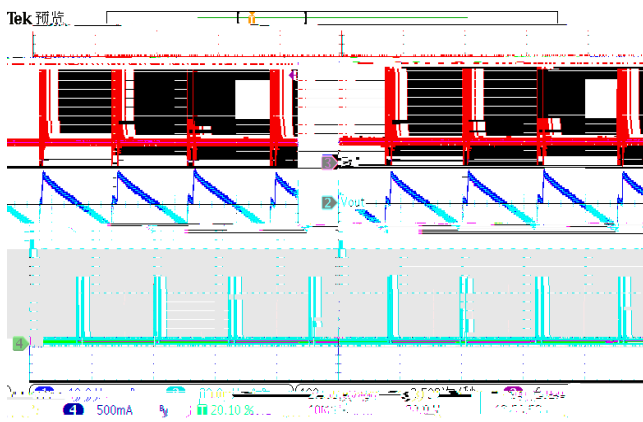

Figure 20. Output Ripple (Iload=10mA)

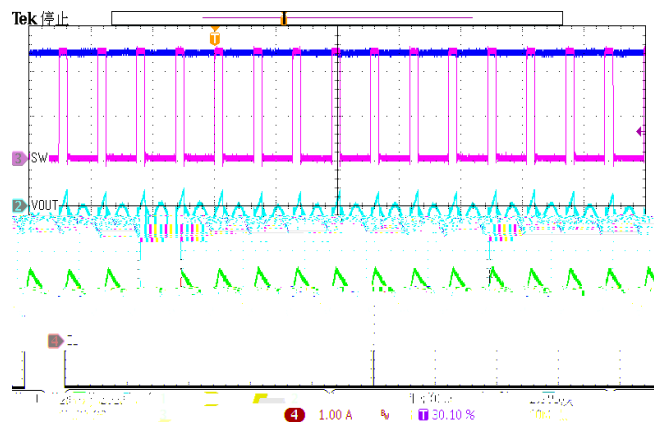

Figure 21. Output Ripple (Iload=1A)

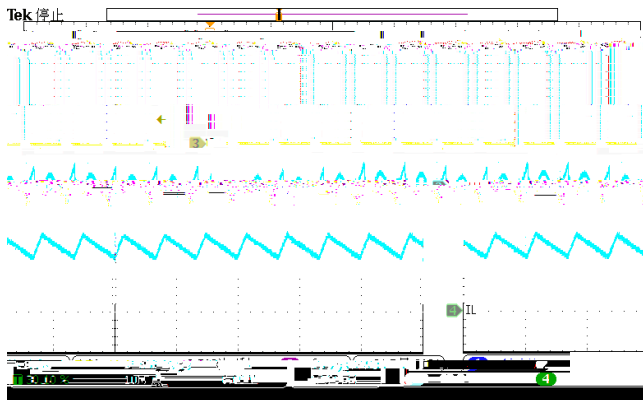

Figure 22. Output Ripple (Iload=3A)

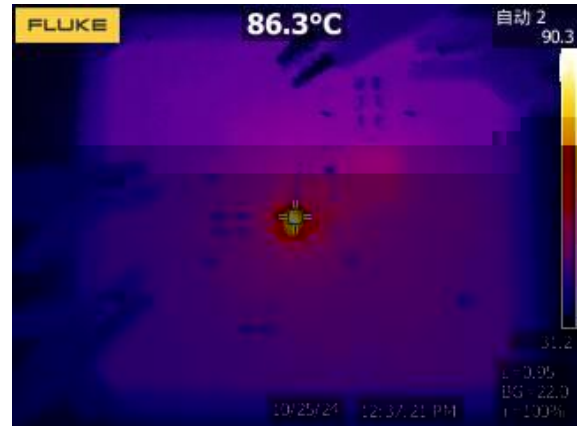

Figure 23. Thermal, 12VIN, 5Vout, 3A

---

1.

2.

3.

4.

---

# TAPE AND REEL INFORMATION

