2.8V-6V Vin 3A Synchronous Step Down Convertor

-
-
-
-
-
-
-
-

SCT2130

Revision 1.0: Release to production.

Revision 1.1: Update the accuracy range of V_{FB} .

Revision 1.2: Update the upper limits for I_Q , I_{SD} , R_{HS} , and R_{LS} .

Revision 1.3: Update DEVICE ORDER INFORMATION and the parameter of $ILIM_{LS}$.

ORDERABLE DEVICE	PACKAGING TYPE	STANDARD PACK QTY	PACKAGE MARKING	PINS	PACKAGE DESCRIPTION
SCT2130FTAR	Tape & Reel	3000	2130	8	FCQFN2x1.5-8

Over operating free-air temperature unless otherwise noted ⁽¹⁾

DESCRIPTION	MIN	MAX	UNIT
VIN, EN, PG, SW, VOUT	-0.3	7	V
SS, FB	-0.3	5.5	V
Operating junction temperature $T_J^{(2)}$	-40	150	C
Storage temperature T_{STG}	-65	150	C

PG

VOUT

SW

SS

GND

EN

Top View: QFN-8L 1.5mm x 2mm, Plastic

(1)

(2)

PG	1	
VIN	2	
SW	3	Switch output. SW is driven up to VIN through the high-side power MOSFET during on-time. The inductor current drives SW to negative voltage through low-side power MOSFET during

SCT2130

$V_{IN}=5V$, $T_J=-40^{\circ}C\sim 125^{\circ}C$, typical values are tested under $25^{\circ}C$.

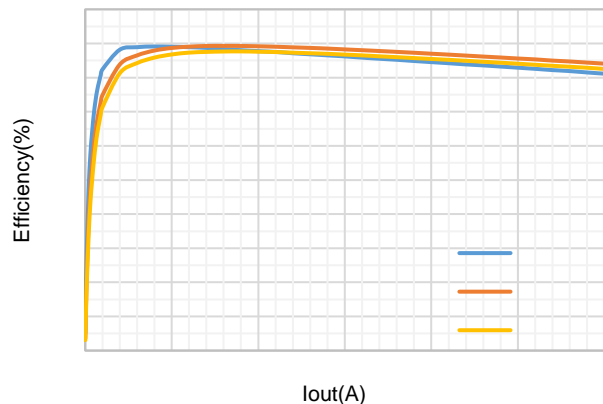

Figure 1. Efficiency vs Load Current, Vout=1.2V

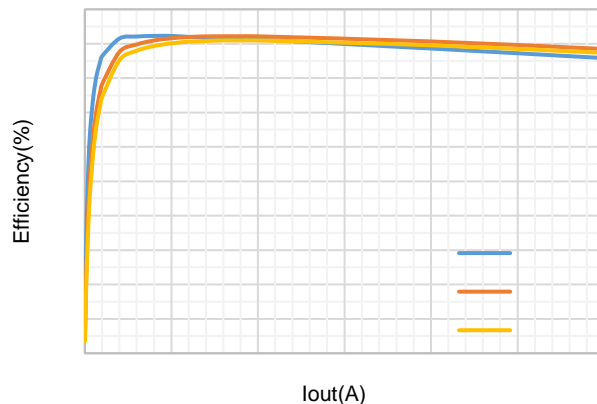

Figure 2. Efficiency vs Load Current, Vout=1.8V

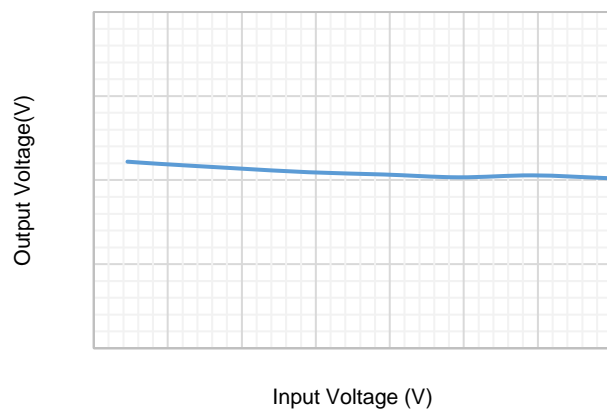

Figure 3. Line Regulation, Io=1.5A

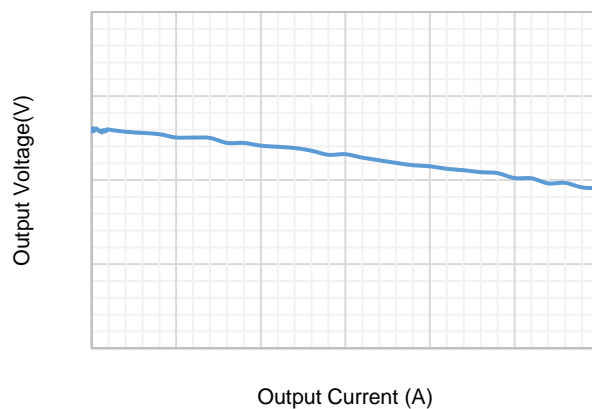

Figure 4. Load Regulation, Vin=5V

Figure 5. V_{FB} vs Temperature

Figure 6. UVLO vs Temperature



Figure 7. Functional Block Diagram

Overview

The SCT2130 is a 2.8V-6V input, 3A output, synchronous buck converter with built-in 25mΩ high-side and 20mΩ R_{ds(on)} low-side power MOSFETs. It implements constant on time control to regulate output voltage, providing excellent line and load transient response, and internal error amplifier integrated improve the line and load regulation.

The switching frequency is fixed 2.1MHz. The SCT2130 features programmable soft start time to avoid large inrush current and output voltage overshoot during startup. The device also supports monolithic startup with pre-biased output condition. The SCT2130 operates in Forced Continuous Conduction Mode (FCCM) to achieve low light load ripple. The quiescent current is typically 1000uA under no load and no switching.

The SCT2130 full protection features include the input under-voltage lockout, over current protection with cycle-by-cycle current limiting and hiccup mode, output hard short protection and thermal shutdown protection.

Constant On-time Control

Constant on-time (COT) control is employed to provide fast transient response and easy loop stabilization. At the beginning of each cycle, the high-side MOSFET is turned on for a fixed one shot time ON-time period. The one shot time is fixed by-cycle based to maintain a pseudo-fixed frequency over the input voltage range. SCT2130 turns off high-side MOSFET after the fixed-on time and turns on the low-side MOSFET. SCT2130 turns off the low-side MOSFET once the output voltage dropped below the output regulation, the one-shot timer then reset and the high-side MOSFET is turned on again. The on-time is inversely proportional to the input voltage and proportional to the output voltage. It can be calculated using the following Equation 1:

$$\text{ON-time} = \frac{V_{OUT}}{V_{IN}} \times \frac{1}{f_s} \quad (1)$$

Where:

- V_{OUT} is the output voltage.
- V_{IN} is the input voltage.
- f_s is the switching frequency.

After an ON-time period, the regulator goes into the OFF-time period. The OFF-time period length depends on V_{FB} in most cases. It will end when the FB voltage decreases below 0.6

SCT2130

When the device is disabled, the part automatically goes into output discharge mode, and its internal discharge MOSFET in VOUT pin provides a discharge path for the output capacitor.

Output Voltage

The SCT2130 regulates the internal reference voltage at 0.6V. The output voltage is set by a resistor divider from the output node to the FB pin. It is recommended to use 1% tolerance or better resistors. Use Equation 2 to calculate resistance of resistor dividers. To improve efficiency at light loads, larger value resistors are recommended. However, if the values are too high, the regulator will be more susceptible to noise affecting output voltage accuracy.

$$\text{---} \tag{2}$$

Where:

- R_{FB_TOP} is the resistor connecting the output to the FB pin.
- R_{FB_BOT} is the resistor connecting the FB pin to the ground.

Soft Start (SS)

The SCT2130 has an external soft start (SS) pin that ramps up the output voltage at a controlled slew rate to avoid capacitor. t_{ss} can be calculated with Equation 3:

$$\text{---} \tag{3}$$

Where:

- C_{ss} is the external SS capacitor.
- I_{ss}

The minimum SS capacitor is recommended to be 1nF.

Over Current Protection (OCP) and Hiccup Mode

In each switching cycle, the inductor current is sensed by monitoring the high-side MOSFET during the ON period and the low-side MOSFET during the OFF period. When the inductor current (I_L) reaches the high-side MOSFET peak current limit (typically 4.5A) during the ON period, the high-side MOSFET is forced off immediately to prevent the current from rising further. Then the low-side MOSFET turns on, and stays on until I_L drops below the low-side MOSFET valley current limit (typically 3.5A). If output loading continues to increase, output will drop below the V_{UVP} , and SS pin is discharged such that output is 0V. Then the device will count for 7 cycles of soft-start time for hiccup -start period. If overload or hard short condition still exists during soft-start and make FB voltage lower than V_{UVP} , the device enters into turning-off mode again. When overload or

pulled to GND to indicate an output failure. If VIN and EN are not available, and PG is pulled up by an external power supply, PG will self-
-up resistor is used, the voltage on the pin is below 0.4V.

Thermal Shutdown

Once the junction temperature in the SCT2130 exceeds 160°C, the thermal sensing circuit stops converter switching and restarts with the junction temperature falling below 140°C. Thermal shutdown prevents the damage on device

Typical Application

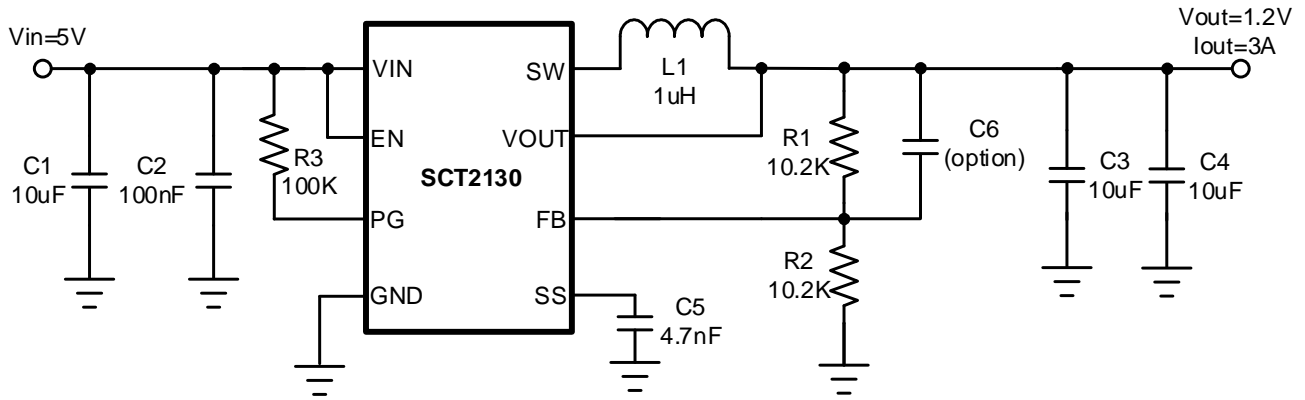

Figure 8. SCT2130 Design Example, 1.2V Output

Design Parameters

Design Parameters	Example Value
Input Voltage	5V Normal 2.8V to 6V

Output Voltage

Output Capacitor Selection

The selection of output capacitor will affect output voltage ripple in steady state and load transient performance.

The output ripple is essentially composed of two parts. One is caused by the inductor current ripple going through the Equivalent Series Resistance ESR of the output capacitors and the other is caused by the inductor current ripple charging and discharging the output capacitors. To achieve small output voltage ripple, choose a low-ESR output capacitor like ceramic capacitor. For ceramic capacitors, the capacitance dominates the output ripple. For simplification, the output voltage ripple can be estimated by Equation 12 desired.

(12)

Where:

- ΔV_{OUT} is the output voltage ripple.
- f_{SW} is the switching frequency.
- L is the inductance of inductor.
- C_{OUT} is the output capacitance.
- V_{OUT} is the output voltage.
- V_{IN} is the input voltage.

Due to ΔC degrading under DC bias, the bias voltage can significantly reduce capacitance. Ceramic capacitors can lose most of their capacitance at rated voltage. Therefore, leave margin on the voltage rating to ensure adequate effective capacitance. Typically, $\Delta C/C = -0.00144 T_c (IN) T_c$

Application Waveforms

$V_{IN}=5V$, $V_{OUT}=1.2V$, unless otherwise noted

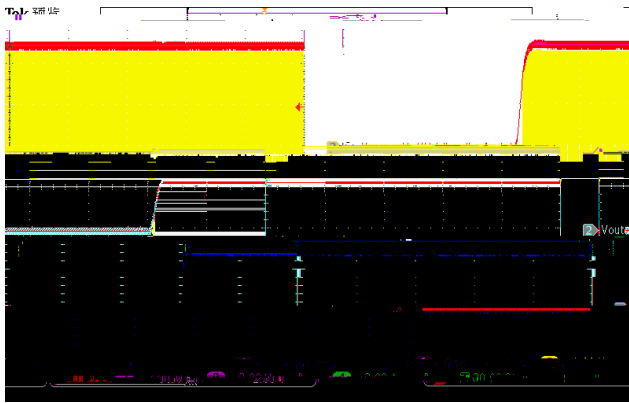

Figure 9. Power up ($I_{LOAD}=3A$)

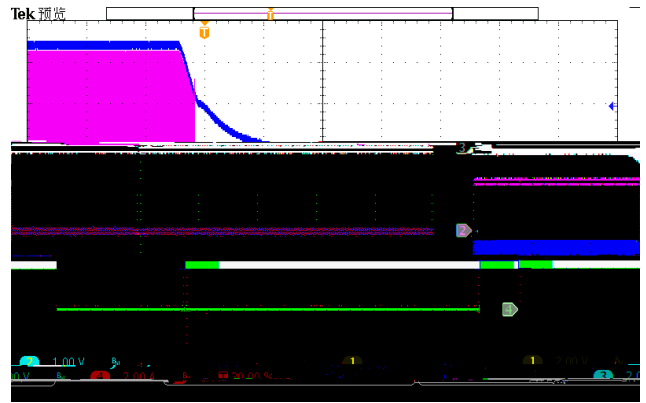

Figure 10. Power down ($I_{LOAD}=3A$)

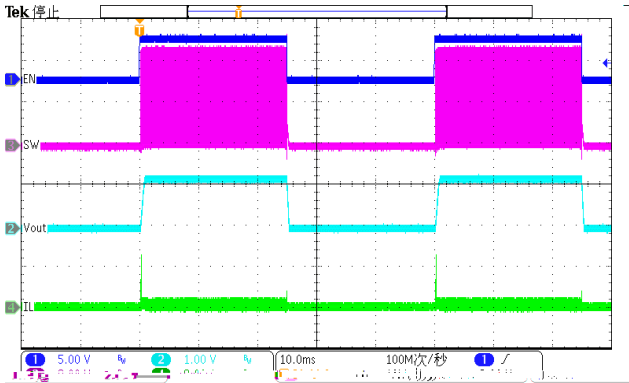

Figure 11. EN toggle ($I_{LOAD}=0.1A$)

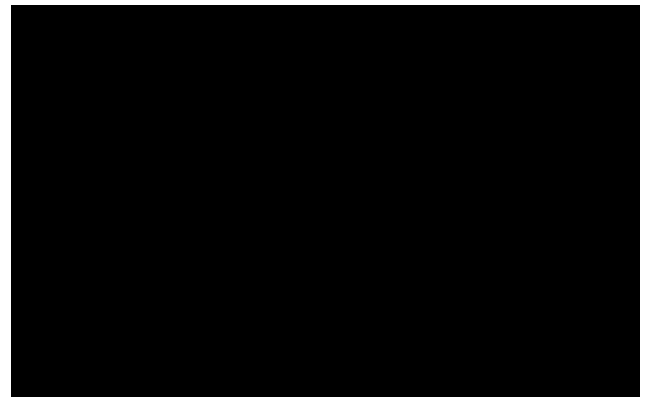

Figure 12. EN toggle ($I_{LOAD}=3A$)

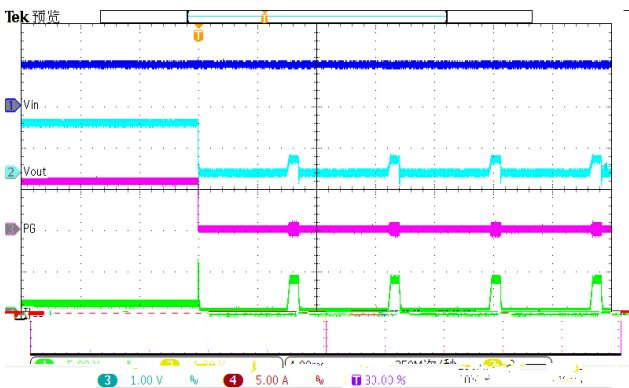

Figure 13. Over Current Protection (1A to hard short)

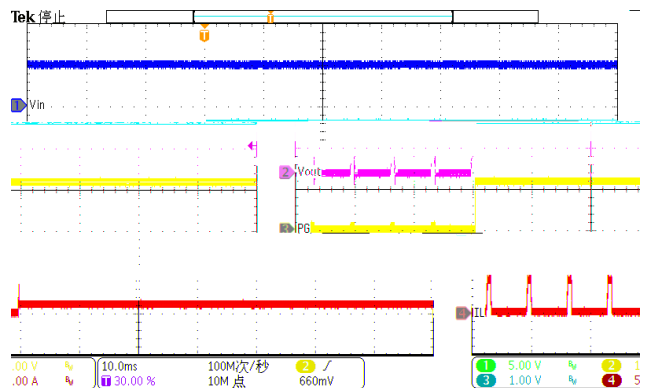

Figure 14. Over Current Release (hard short to 1A)

Application Waveforms

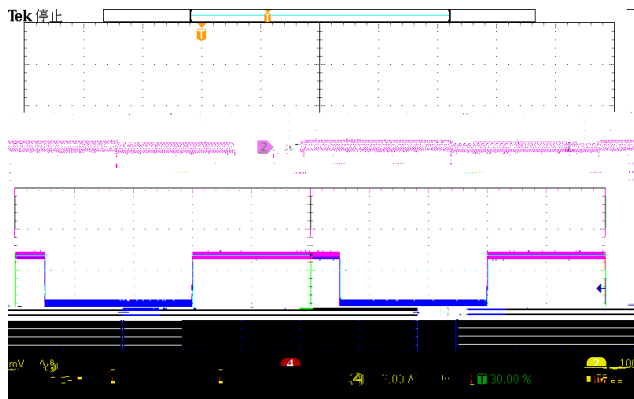

Figure 15. Load Transient (0.3A-2.7A, 1.6A/us)



Figure 16. Load Transient (0.75A-2.25A, 1.6A/us)

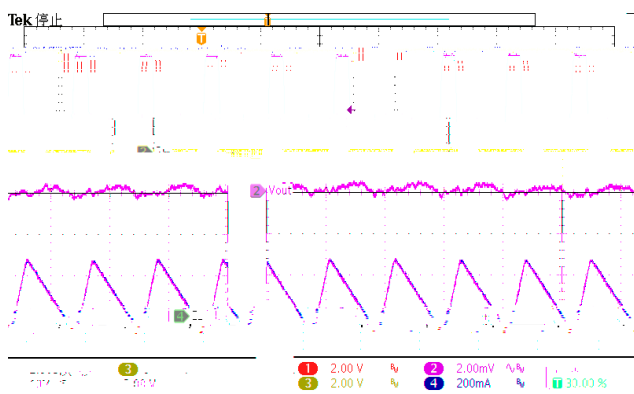

Figure 17. Output Ripple ($I_{LOAD}=100mA$)

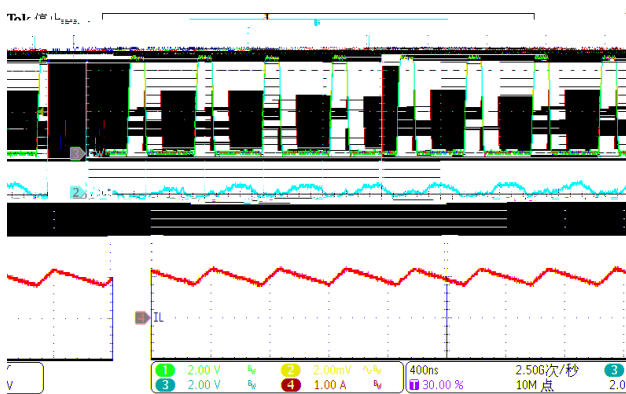

Figure 18. Output Ripple ($I_{LOAD}=1A$)

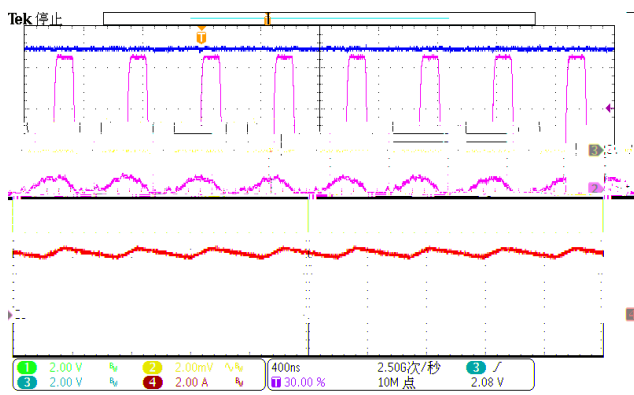

Figure 19. Output Ripple ($I_{LOAD}=3A$)



Figure 20. Thermal, $V_{IN}=5V$, $V_{OUT}=1.2V$, $I_{LOAD}=3A$

